

SlimLine Sensor

Type 9130B... up to 9136B...

0 ... 3 kN up to 0 ... 62 kN

Quartz sensor with extremely flat design for measuring dynamic and quasistatic forces. High resolution, high rigidity and extremely small dimensions characterize this sensor. Its characteristics make it ideal for mounting in mechanical structures. Its case is hermetically sealed and it has an integrated splash-proof connecting cable with connector.

The SlimLine sensors are supplied **uncalibrated** and must be calibrated in situ after mounting for absolute measurements.

- Extremely small size with a wide measuring range
- Flexible mounting in force shunt mode
- Also suitable for tensile forces when preloaded
- Measures practically free of displacement, wear and fatigue
- Measures even small forces with high resolution
- Sealed case (IP65)
- Integrated non-detachable cable with Viton® cable covering

Description

The force F to be measured acts on the sensor via the preload-ing or mounting structure and produces an electric charge directly proportional to the force. This is measured by an electrode and fed to the charge amplifier via the integrated cable.

Application

Because of their high rigidity, SlimLine sensors are especially suitable for measuring rapidly changing forces, but quasistatic measurements over several minutes are also possible. The SlimLine sensor is especially suitable for measuring forces in shunt mode (Fig. 4). This means that the sensor is embedded and preloaded in a structure; it is therefore loaded only with part of the process force. Its small size is ideal for installation in structures such as force plates, fitting strips and tools. The sensor is used in industrial production processes wherever forces are monitored or measured. Used with a ControlMonitor, this sensor is ideal for quality control and monitoring in large scale industrial production.

Examples of Application

- Monitoring of press forces, punching forces etc.
- Tool monitoring
- Measurement of large forces in force shunt mode
- Incorporation in dynamometers with small dimensions

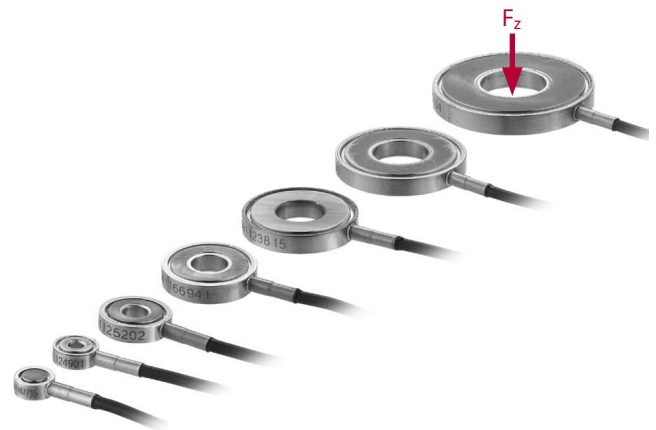

Technical Data

Type	Measuring Range F_z [kN]	Overload F_z [kN]	Sensitivity [pC/N]	Rigidity [kN/ μm]
9130B...	0 ... 3	3,5	$\approx -3,5$	$\approx 1,0$
9131B...	0 ... 2,5	3	$\approx -4,0$	$\approx 0,7$
9132B...	0 ... 7	8	$\approx -3,8$	$\approx 1,8$
9133B...	0 ... 14	17	$\approx -3,8$	$\approx 2,5$
9134B...	0 ... 26	30	$\approx -3,8$	$\approx 5,6$
9135B...	0 ... 36	42	$\approx -3,8$	$\approx 7,0$
9136B...	0 ... 62	72	$\approx -3,8$	$\approx 8,0$

Linearity (preloaded)	%/FSO	$\leq \pm 1,0$
Hysteresis (preloaded)	%/FSO	$\leq 1,0$
Response threshold	N	$< 0,01$
Operating temperature range	$^{\circ}\text{C}$	$-20 \dots 120$
Preloading force (recommended)	F_v	
Direct connection ¹⁾	%/FS	≈ 50
Shunt mode	%/FS	≈ 20
Degree of protection ²⁾	EN60529	IP65

¹⁾ The preloading force must be selected according to the tensile/compression force range required and according to the information on Page 3 concerning bending moment.

²⁾ The IP degree of protection according to EN60529 is ascertained with water. Oils, emulsions, coolant/cutting fluids etc. mostly have a better wetting and penetration capacity. For contact with such fluids, the degree of protection must be classified as being correspondingly lower.

Dimensions

Type	D [mm]	d [mm]	H [mm]	Weight (without cable) m [g]
9130B...	8,0	2,7	3,0	1
9131B...*	7,0	–	3,0	1
9132B...	12,0	4,1	3,0	2
9133B...	16,0	6,1	3,5	3
9134B...	20,0	8,1	3,5	5
9135B...	24,0	10,1	3,5	7
9136B...	30,0	12,1	4,0	14

* Type 9131B... without a bore [d]

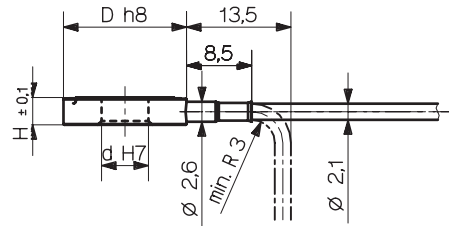

Fig. 1: Dimensions SlimLine Sensor

Sensor Mounting

SlimLine sensors should basically be used only preloaded in a mounting structure, either directly in the force flux of a separate component or in force shunt mode embedded in a machine structure. Whereas with direct force measurement, the largest part of the process force flows through the sensor, in the case of force shunt measurements it is loaded with only a very small part of the process force. SlimLine sensors are supplied uncalibrated, because in any case they must be calibrated in situ in the mounting structure for absolute measurements.

Direct Force Measurement in the Force Flux

With direct force measurement, almost the entire process force flows through the sensor. The measuring range must therefore be selected so that the sum of preloading force F_v and maximum occurring process force F_z is within the measuring range of the sensor. The mounting surfaces must be flat, rigid and ground (Fig. 3). The preloading bolt produces a force shunt of $\approx 7 \dots 10 \%$ and a correspondingly reduced sensitivity. In general, a preloading force of at least 20 % of the measuring range is recommended; with tensile forces this should be increased accordingly. If possible (considering the process force), preloading of 50 % of the measuring range should be used, because the tolerance with regard to bending moments is then at its greatest, see Page 3.

Mounting Dimensions

Mounting Dimensions Type	Thread	Bore Diameter d1 [mm]	Plate Thickness ¹⁾ A [mm]
9130B...	M2,5	2,9	8,0
9132B...	M4	4,3	8,0
9133B...	M6	6,4	12,0
9134B...	M8	8,4	16,0
9135B...	M10	10,5	20,0
9136B...	M12	13,0	24,0

¹⁾ Recommended minimum plate thickness

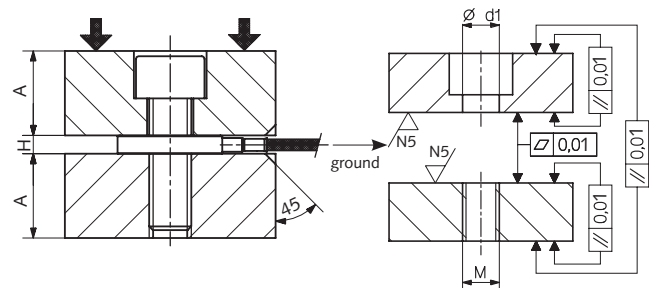

Fig. 3: Dimensions for direct force flux mounting

9130B_000-110e-11.06

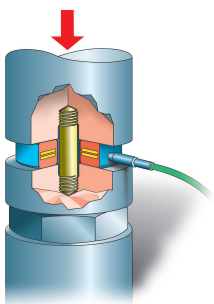

Fig. 2: Direct force measurement

Bending Moment

Bending moments may not only have a negative influence on the measurement, but may even lead to destruction of the sensor. However, when the sensor is mounted in a thrust rod or a press punch, it is often impossible to avoid bending moments entirely.

The permissible value for the bending moment M_b is dependent on the sum of the preloading force F_v and the current process force F_z applied, in which the maximum possible bending moment $M_{b,max}$ is reached at $F_v+F_z = B/2$.

Maximum Possible Bending Moment

Type	Range Limit Value B [kN]	Max. possible Bending Moment $M_{b,max}$ [N·m]
9130B...	3,0	1,50
9131B...	2,5	1,50
9132B...	7,0	5,15
9133B...	14,0	15,00
9134B...	26,0	35,00
9135B...	36,0	62,00
9136B...	62,0	134,00

With the table values for B and $M_{b,max}$, the permissible pure bending moment as a function of the preload force F_v and the process force F_z can be estimated as follows:

$$(1a) \quad M_{b,perm.} \leq \frac{2 \cdot M_{b,max}}{B} \cdot (F_v + F_z) \quad F_v + F_z \leq B/2$$

$$(1b) \quad M_{b,perm.} \leq \frac{2 \cdot M_{b,max}}{B} \cdot (B - F_v - F_z) \quad F_v + F_z \geq B/2$$

In the bending moment graph, the equations (1) limit the range of the permissible bending moment as a function of F_v and F_z .

Bending Moment Graph



Bild 4: Bending moment graph (pure bending moment)

Attention

If a bending moment $M_b = F_{x,y} \cdot h$ is produced by a lateral force $F_{x,y}$ at a distance h from the reference plane, this will lead to a shear force $F_{x,y}$ in the sensor plane. In this case, the maximum permissible bending moment is lower than the permissible value for a pure bending moment determined using the equations (1).

Example 1

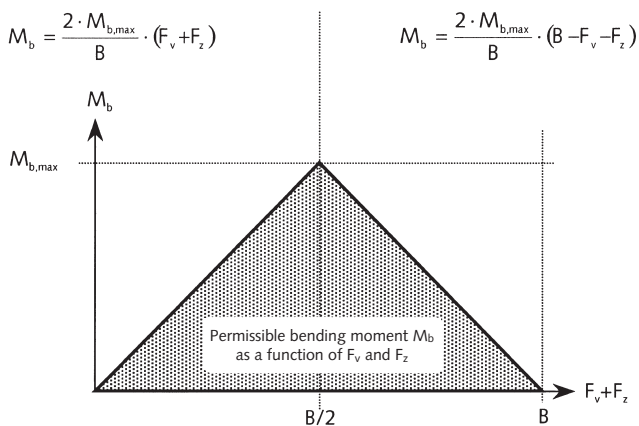
A SlimLine sensor Type 9135B... is preloaded with 10 kN. What bending moment is acceptable for process forces in the range of 0 ... 12 kN?

$F_v+F_{z,min} = 10 + 0 = 10 \text{ kN} \leq B/2 \rightarrow (1a) \rightarrow M_b \leq 34,4 \text{ N}\cdot\text{m}$
 $F_v+F_{z,max} = 10 + 12 = 22 \text{ kN} \geq B/2 \rightarrow (1b) \rightarrow M_b \leq 48,2 \text{ N}\cdot\text{m}$
 At no time must the bending moment be greater than 34,4 N·m.

Example 2

A SlimLine sensor Type 9132B... is preloaded with 3 kN. How wide is the measuring range with a bending moment of 2 N·m? By resolving (1) according to F_z , we get the equations (2) with which the permissible measuring range for the process force F_z can be calculated as a function of a bending moment.

$$(2a) \quad F_{z,min} \geq \frac{B \cdot M_b}{2 \cdot M_{b,max}} - F_v$$

$$(2b) \quad F_{z,max} \leq B \cdot \left(1 - \frac{M_b}{2 \cdot M_{b,max}}\right) - F_v$$

Inserting the values for B, $M_{b,max}$ and F_v produces the permissible measuring range for F_z

from (2a) $-1,64 \text{ kN} \leq F_z \leq 2,64 \text{ kN}$ from (2b).

Attention

Lateral forces $F_{x,y}$ and/or a torque M_z further reduce the measuring range.

When the equations (2a) and (2b) are resolved according to F_v , the minimum preload force required or the maximum permissible preload force can be calculated as a function of the other parameters.

Mounting in Force Shunt Mode

The widest variety of measuring problems can be solved with the SlimLine sensor mounted in force shunt mode. The mounting surface must be flat and be ground as finely as possible. Preferably, the SlimLine sensor is mounted with a preloading disk from Kistler (optional accessories) and preloaded to 10 ... 20 % of the measuring range. The surfaces of the structure and preloading disk must all be ground jointly, with the preloaded sensor integrated in the structure. The slight projection P recommended for the preloading disk is achieved by then removing the sensor and grinding over the structure one path with the same depth of cut. This ensures a reproducible force shunt arrangement and good linearity.

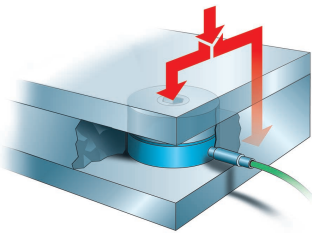

Fig. 4: Force shunt measuring

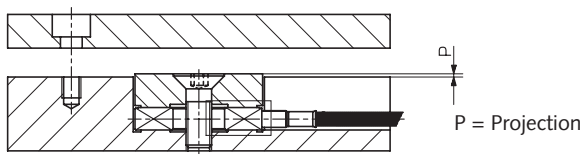

Fig. 5: Installation with preloading disk Type 9410A...

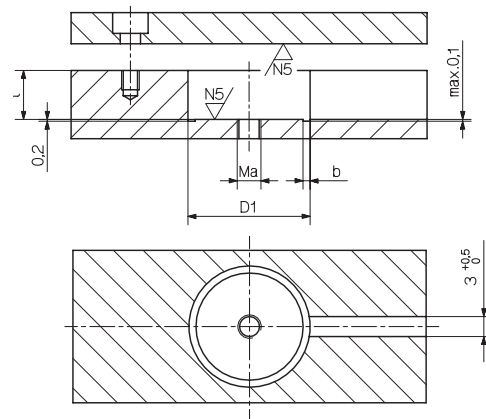

Fig. 6: Installation in force shunt mode

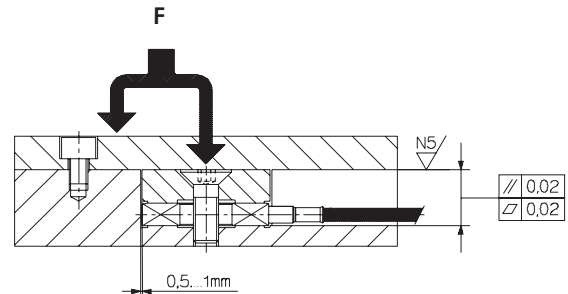

Fig. 7: Assembly with preloading disk Type 9410A...

Mounting Dimensions

SlimLine Sensor Type	Thread Ma	Bore Diameter D1 [mm]	Bore Depth t [mm]	Undercut b [mm]	Projection P [µm]
9130B...	M2	8,5	6,5	1,2	0 ... 2
9132B...	M2,5	12,5	6,5	1,2	0 ... 2
9133B...	M3	16,5	7,7	1,2	0 ... 3
9134B...	M4	20,5	7,7	1,2	0 ... 3
9135B...	M5	24,5	7,7	1,5	0 ... 3
9136B...	M6	30,5	9,5	1,5	0 ... 3

Preloading Disk

Type	for SlimLine Sensor	Thread	D2 [mm]	d2 [mm]	H1 [mm]	L [mm]
9410A0	9130B...	M2	8,0	2,7	3,55	8,0
9410A2	9132B...	M2,5	12,0	2,7	3,55	8,0
9410A3	9133B...	M3	16,0	3,2	4,25	10,0
9410A4	9134B...	M4	20,0	4,3	4,25	10,0
9410A5	9135B...	M5	24,0	5,3	4,25	10,0
9410A6	9136B...	M6	30,0	6,4	5,50	14,0

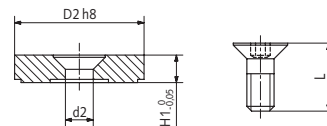

Fig. 8: Preloading disk with countersunk screw (Accessories included)

9130B_000-110e-11.06

Optional Accessories

	Type
• Preloading disk for SLS sensor Type 9130B...	9410A0
• Preloading disk for SLS sensor Type 9132B...	9410A2
• Preloading disk for SLS sensor Type 9133B...	9410A3
• Preloading disk for SLS sensor Type 9134B...	9410A4
• Preloading disk for SLS sensor Type 9135B...	9410A5
• Preloading disk for SLS sensor Type 9136B...	9410A6
• Coupling KIAG 10-32 neg. – BNC pos.	1721
• Coupling KIAG 10-32 neg. – KIAG 10-32 neg.	1729A

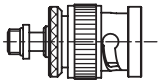

Fig. 9: Coupling Type 1721



Fig. 10: Coupling Type 1729A

(see also data sheets "Cables for Force, Torque and Strain Sensors" 1631C_000-346 and "Coaxial Cable Connectors, Cable Sockets, Couplings and Accessories" 1700A_000-347).

Ordering Key

Measuring Range		Type 913	B	
0 ... 3 kN	0			
0 ... 2,5 kN	1			
0 ... 7 kN	2			
0 ... 14 kN	3			
0 ... 26 kN	4			
0 ... 36 kN	5			
0 ... 62 kN	6			
with KIAG 10-32 pos. integrated	2			
with Mini-Coax neg.	3			
Cable length L = 2 m (standard)	1			
Specify cable length L in m (L _{min} = 0,1/L _{max} = 2 m)	9			

The following connections can be used:

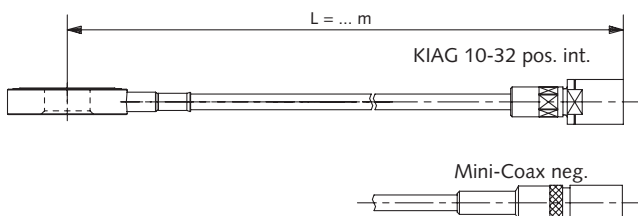

Viton® is a registered trademark of DuPont Performance Elastomers.

Further Information

SLS Assembly

Two, three or four SlimLine sensors are incorporated in a sealed (IP65) plug connection with an individually selected cable length. Signals can be recorded as summation signals (parallel connection) or as single signals (series connection). Further information can be obtained from data sheet SlimLine Kit (9130BA_000-168).

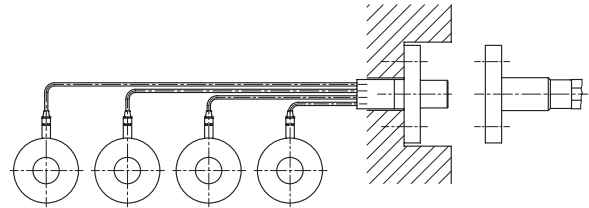

Fig. 11: SLS assembly

SLS Quartz Force Link

The calibrated SLS force links Types 9173B... to 9176B... are suitable for the measurement of tensile and compression forces. The SlimLine sensors are mounted ground-isolated in preloading elements. For further information, see the data sheet for SlimLine force links (9173_000-112).

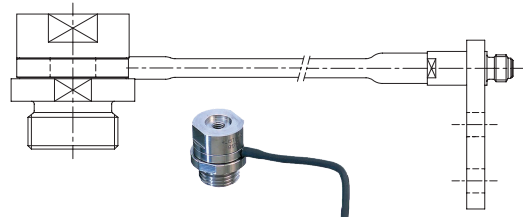

Fig. 12: Quartz force link